

Fisher & Paykel

Active Smart™ refrigerator
E402B, E442B, E522B & RF610A models

**Installation instructions
and User guide**

Product model number	Product name	Country of origin
22407	E402BRXFDI (E402B Integrated)	Made in New Zealand
22408	E402BLXFDI (E402B Integrated)	Made in New Zealand
22409	E402BLXFD (E402B)	Made in New Zealand
22410	E402BRXFDU (E402B)	Made in New Zealand
22403	E442BLXFD (E442B)	Made in Thailand
22401	E442BRXFDU (E442B)	Made in Thailand
22405	E522BLXFD (E522B)	Made in Thailand
22404	E522BRXFDU (E522B)	Made in Thailand
22406	RF610ADUX (RF610A)	Made in Thailand

Key

E = Electronic Refrigerator

RF = Freestanding

402

442

522 = Capacity (L)

610

B = Bottom Mount Freezer

A = French Door and Drawer

R = Right-hand Hinged Door

L = Left-hand Hinged Door

X = Stainless Steel finish

F = Flat Door

D = Designer Handle

U = Water and Internal Ice

Introduction	2
Safety and warnings	3
Installation instructions	5
Non Ice & Water display	13
Ice & Water display	15
Using the display options	17
Bottle Chill	17
Fast Freeze	18
The temperature of your refrigerator and freezer	18
Settings	19
User warnings	20
Using your water dispenser	21
Water filter	22
Using your ice maker	23
<i>Active Smart™</i> special features	25
<i>Active Smart™</i> maintenance	27
Cleaning and caring for your refrigerator	28
On vacation/holiday	31
Refrigerator sounds	32
Storing food in your refrigerator	33
Storing food in your freezer	34
Troubleshooting	36
Wiring diagrams	40

Important!

SAVE THESE INSTRUCTIONS

The models shown in this User Guide may not be available in all markets and are subject to change at any time. For current details about model and specification availability in your country, please visit our local website listed on the back cover or contact your local Fisher & Paykel dealer.

Thank you for buying a Fisher & Paykel *Active Smart™* refrigerator. Thousands of hours of food care research and 75 years of refrigeration experience has been programmed into your refrigerator to give you the best possible performance.

With the Ice & Water models we have achieved water dispensing through the door without compromising storage space or access in the refrigerator. The automatic ice maker means ice is always on hand, ready for your use.

We hope you enjoy your new refrigerator.

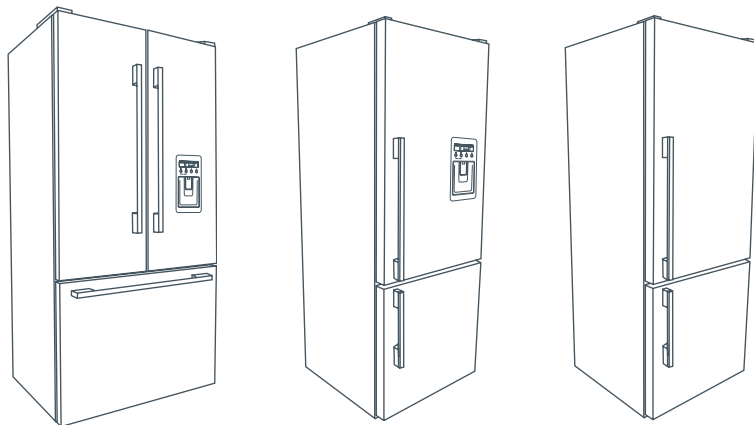

Fig.1 Active Smart™ refrigerators

Important!

It is important that this User Guide should be retained with your Active Smart™ refrigerator for future reference. Should the appliance be sold or transferred to another owner, please ensure that the User Guide is left with the appliance. This will ensure that the new owner can familiarise themselves with the information and warnings contained within the Guide.

⚠ WARNING!**Electric Shock Hazard**

Read and follow the SAFETY AND WARNINGS outlined in this User Guide before operating this appliance.

Failure to do so can result in death, electric shock, fire or injury to persons.

Use this appliance only for its intended purpose as described in this User Guide.

Important safety precautions

Warning

When using this appliance always exercise basic safety precautions including the following:

Danger

- *This appliance is not intended for use by children or infirmed persons without supervision. This is especially important when using the freezer drawer compartment. Young children should be supervised to ensure they do not play with the appliance.*
- *Risk of child entrapment. Before you throw away your old refrigerator:*
 - *Take off the doors*
 - *Leave the shelves in place so that children may not easily climb inside.*

Disposal

- *Extreme care must be taken when disposing of your old appliance to avoid hazards. The refrigerant gas must be safely removed and for the safety of young children, remove doors.*
- *Your Fisher & Paykel Appliances Authorised Service Centre will be able to give advice on environmentally friendly methods of disposing of your old refrigerator.*

Electrical

- *This appliance must be properly installed in accordance with the installation instructions before it is used.*
- *Never unplug your refrigerator by pulling on the power cord.*
- *Always grip the plug firmly and pull straight out from the outlet socket.*
- *Do not plug in any other appliance at the same power point outlet socket as your refrigerator is using. Do not use extension cords or double adapters with these products.*
- *Repair or replace immediately all electric service cords that have become frayed or otherwise damaged. Do not use a cord that shows cracks or abrasion along its length or at either the plug or appliance end.*

If the power supply cord is damaged, it must only be replaced by your Fisher & Paykel Appliances Authorised Service Centre because special purpose tools are required.

Safety and warnings (all models)

- *When moving your appliance away from the wall, be careful not to roll over or damage the power cord.*
- *Unplug your refrigerator before cleaning or replacing the interior light bulb.*

Storing food and drinks

- *Never store volatile or flammable materials in your refrigerator as they may explode.*
- *Never freeze liquids in glass containers. Liquid expands during freezing, which may cause the container to explode.*
- *Never freeze carbonated drinks. They may explode.*
- *Do not consume food if it is too cold. Food removed from the freezer compartment may be cold enough to cause damage when brought into contact with bare skin, eg frozen ice cubes.*

Power failure – food safety

- *Do not refreeze frozen foods that have thawed completely. Follow the recommendations below if you discover food in your freezer has thawed:*
 - 1) *Ice crystals still visible – food may be refrozen but should be stored for a shorter period than recommended.*
 - 2) *Thawed but refrigerator cold – refreezing generally not recommended. Fruits and some cooked food can be refrozen but use as soon as possible. Meat, fish, poultry – use immediately or cook then refreeze. Vegetables – discard as they usually go limp and soggy.*
 - 3) *Thawed and warmer than 5°C. Discard all food.*
- *Do not refreeze frozen foods that have thawed completely. The food may be dangerous to eat.*

Important!

Cleaning

- *Many commercially available cleaning products contain solvents which may attack plastic components of your refrigerator or freezer and cause them to crack. Please refer to the cleaning care section of this booklet for further advice.*

⚠ WARNING!



Electric Shock Hazard

Read and follow the SAFETY AND WARNINGS outlined in this User Guide before operating this appliance, pages 3 – 4.

Failure to do so can result in death, electric shock, fire or injury to persons.

Please follow the steps for installation to ensure your appliance operates correctly.

1. Power

- The appliance must be installed so the plug is accessible.
- To ensure that the appliance is not accidentally switched off, connect your refrigerator to its own power point. Do not plug in any other appliance at this power point or use extension cords and double adaptors, as the combined weight of both power cords can pull the double adaptor from a wall outlet socket.
- For power requirements, refer to the information on the serial plate located at the front bottom right-hand side of the refrigerator when the door is open.
- It is essential that the appliance be properly grounded (earthed).

2. Location

- Your refrigerator should not be located in direct sunlight or next to any heat generating appliance such as a cooktop, oven or dishwasher.

6 Installation instructions (all models)

E402B, E442B, E522B (Non Ice & Water and Ice & Water models)

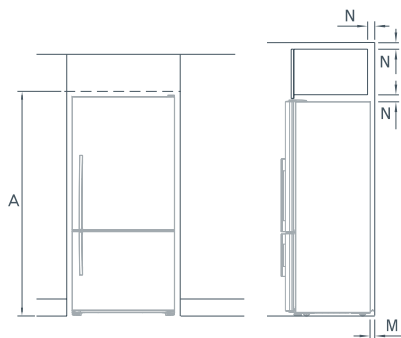

Flush with refrigerator chassis – full door rotation

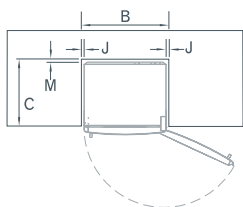

Flush with refrigerator door – full door rotation

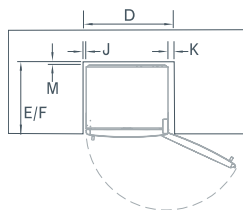

Flush with refrigerator door – 90° door rotation*

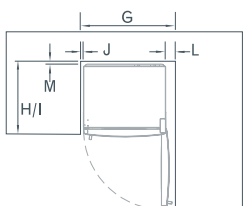

RF610A

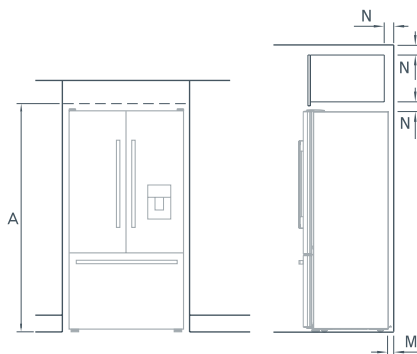

Flush with refrigerator chassis – full door rotation

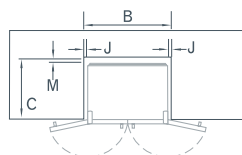

Flush with refrigerator door – full door rotation

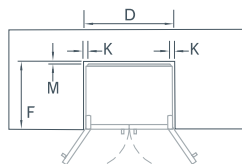

Flush with refrigerator door – 90° door rotation*

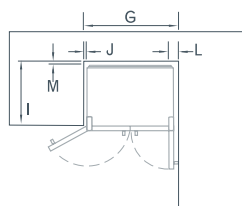

*If the appliance is installed in a corner, a side clearance of 400 mm on the hinge side allows for full drawer/shelf access and removal.

3. Ventilation and installation

- To ensure adequate ventilation for your refrigerator and it's correct operation see recommended cabinetry dimensions below.
- The appliance is intended to be placed against a wall with a free distance not exceeding 75 mm.
- These measurements do not include space for the water filter at the back of the cabinet as we recommend that the filter is placed as close to the incoming water supply as possible.

Cabinetry dimensions (mm) (including minimum air clearances)	E402B	E442B	E522B	RF610A
A inside height	1745	1745	1745	1810
Flush with refrigerator chassis – full door rotation				
B inside width	675	720	830	940
C inside depth	620	620	620	620
Flush with refrigerator door – full door rotation				
D inside width	705	750	860	1000
E inside depth flush to curved door	675	675	675	–
F inside depth flush to flat door	690	690	690	690
Flush with refrigerator door – 90° door rotation				
G inside width	745	790	900	1010
H inside depth flush to curved door	675	675	675	–
I inside depth flush to flat door	690	690	690	690
Minimum clearances				
J side clearance	20	20	20	20
K side clearance – hinge side flush with door – full rotation	50	50	50	50
L side clearance – hinge side flush with door – 90° rotation	90	90	90	90
M rear clearance (incl. evaporator tray)	30	30	30	30
N vent	50	50	50	50





To continue installation of Non Ice & Water models see page 9.

Important!

- *It is recommended that an authorised plumber in your city or town is used to install the water connection.*
- *The new tubings supplied with the refrigerator are to be used, old tubings from old Ice & Water connections should not be used.*

Installation precautions/warning

- **DO NOT use with water that is microbiologically unsafe or of unknown quality without adequate disinfection before or after the system.**
- **WARNING – connect to potable water supply only.**
- **DO NOT install on line pressure above 900 kPa or below 150 kPa.**
- **DO NOT use on hot water supply, 38°C max.**
- **DO NOT install in a location that is susceptible to freezing temperatures as damage to the housing could occur.**
- **AVOID contamination of pipes during installation.**
- **DO NOT use copper tubing. The plastic tubing supplied should always be used.**

- 1 Read pages 9 – 12 carefully, and then turn refrigerator on.
- 2 The first time you require water out of the dispenser, there will be a delay while the water reservoir fills up.
- 3 Run a further 3 L through the system, stopping intermittently to ensure the reservoir is flushed out. Failure to do this will result in excessive dripping from your dispenser.
- 4 Press  until the Ice menu is highlighted then press  to turn on the ice maker. Press    together to force a cycle. The ice tray will flip. Force another cycle. The ice tray will flip and spill the water into the ice bin. Empty water and replace bin.
- 5 You are now ready to enjoy chilled water and ice dispensing from your Active Smart™ refrigerator. Please note that once installation is complete a few drips may appear out of the dispenser over the next few days as the remaining trapped air is cleared.

Note: If you want to install a water filter see page 22.

Important!

- *All connections must be checked for leaks.*
- *Ensure white 6 mm tubing is routed away from sharp objects, sharp corners (beware of kinking tube as this will stop water flow), clear of the refrigerator unit compartment and not in a location where it can be squashed.*
- *Ensure all push-fit connections are firmly pushed into place. The tube should push in 20 mm before reaching the stop.*
- *If tubing is removed at any point, re-cut the end and re-insert. Tubing must be fully inserted to avoid leaks.*
- *To remove tube from connection points, turn off the isolating faucet, push in the collet and gently pull tubing at the same time, as shown in Diagram 1.*

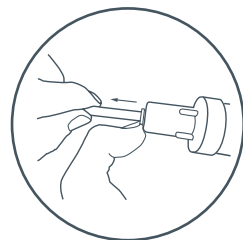

Diagram 1

4. Installation

- It is important that all four corners of the refrigerator base are supported firmly on the floor to eliminate any cabinet movement.
- Installing the appliance on a soft or uneven or unlevel floor may result in twisting of the cabinet and poor sealing of the doors. If the doors do not seal properly, warm air will enter the food storage areas causing the temperature to increase, resulting in food spoilage and food loss.

Your Fisher & Paykel *Active Smart*™ refrigerator is fitted with front and rear rollers, designed for moving the product in the forwards and backwards direction. Avoid moving the product in a sideways direction as this may damage the rollers or the floor covering/surface.

- A** Your refrigerator will arrive with the front feet wound up making moving the product into its final location a simple task.
- B** Roll the refrigerator into its final position making sure there is the correct air gap between the product and surrounding cabinetry. See minimum clearance in cabinetry dimensions table (refer to page 7).

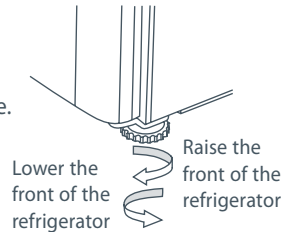

Fig.2 Refrigerator feet

- If required raise the front of the appliance (by turning the adjustable feet clockwise) until it is stable and the doors move towards the closed position on their own, when open.
- The front levelling foot on the hinge side should take the majority of the weight of the cabinet and the cabinet should be stable, ie the cabinet should not rock or wobble.

(Model RF610A only)

- C** Adjust the front feet down until the refrigerator is leaning backward with the front approximately 10 mm higher than the back. This will ensure a good door closing action. (Refer to Fig.2).
- D** Aligning your refrigerator with cabinetry.
 - Align the sides of the refrigerator with the cabinetry by adjusting the hinge side front foot.
 - Adjust the handle side foot until it touches the floor and takes a small amount of weight.
 - Once the refrigerator is in place and aligned with cupboards/alcove push gently on the front top and check if the product is rocking or stable.

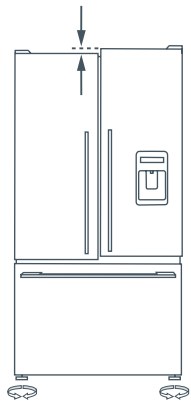

Fig.3 Uneven door alignment

5. Levelling of refrigerator door (model RF610A only)

- For uneven surfaces, front feet can be used to align the 2 doors.
- If left hand door is too low, then unscrew the left hand foot to lift up the cabinet until the two doors top edges are aligned.
- If right hand door is higher, then adjust the right hand foot in the same way.

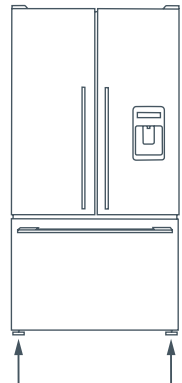

Fig.4 Even door alignment

6. What to do if your product is unstable

- E** Gently push the refrigerator back until the rear rollers contact floor.
- Measure the gap under the front foot, which has come off the floor.
 - Obtain some solid packing material (hardwood, plastic, etc) which fits firmly into the gap under the foot.

Note: Do not use metallic materials that may corrode, stain and/or damage floor coverings.

- F** Wind both front feet up and roll the product out of position.
- Place the packing material in the location diagonally opposite the front roller that lifts off the floor.
 - Make sure the packing material stays in place when the product is pushed back into position.
 - Ideally, the packing material is large enough to rest against the back wall so as to prevent it moving when the cabinet is pushed into position.

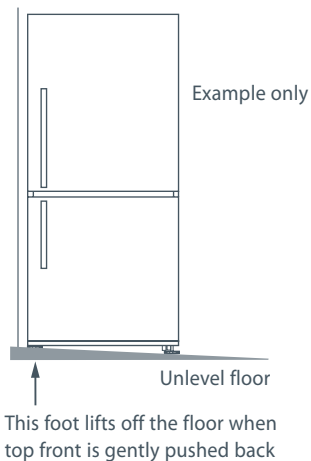

Fig.5 Unstable refrigerator

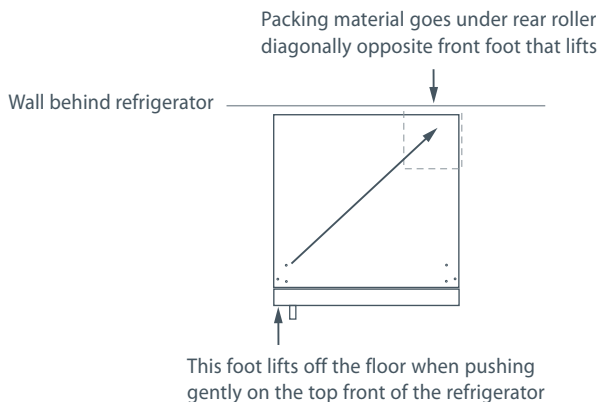

Fig.6 Stabilising your refrigerator

- G** Roll the refrigerator back into position and adjust front feet as per step D. (Check alignment and door closing action are satisfactory).
- Make small adjustments to front feet where necessary.
 - Check that the product is stable (all 4 feet are on the floor). If not return to step E and repeat steps F and G.

Before placing food in the fresh food or freezer compartments

- Remove all packaging. Ensure that all transit clips are removed from the refrigerator. These are small rubber stops located at the back of the shelves.
- Clean the inside of the appliance with a mix of warm water, a little liquid detergent and a soft cloth to remove manufacturing and transportation dust.
- Allow the refrigerator and freezer to run empty for 2 – 3 hours to allow each compartment to cool to the appropriate temperature.
- The appliance may have an odour on its initial operation, but this will go when the refrigerator and freezer have cooled sufficiently.

If you have an Ice & Water refrigerator, please also carry out the following:

- Turn on the ice maker (refer to page 23).
- At first use allow approximately a minute from when the dispensing pad is pushed until water is dispensed. This will allow the tank to fill.
- Run through and discard the first 8 – 10 L of water from the dispenser, stopping intermittently (refer to page 21 – First use). Failure to do this will result in excessive dripping from your dispenser.
- Discard the first bin of ice (refer to page 23 – First use).

You are now ready to enjoy ice and water from your refrigerator.

Please note that once installation is complete a few drips may appear out of the dispenser over the next few days as the remaining trapped air is cleared.

Energy efficiency

- Do not cover your appliances with any material that will prevent air from flowing around the cabinet sides.
- Do not leave the door open for any longer than is necessary.
- Allow good clearances in front of the air ducts within the cabinet for maximum cold air distribution.

12 Installation instructions (all models)

Moving or storing your refrigerator

If your refrigerator is turned off for any reason, wait 10 minutes before turning it back on. This will allow the refrigeration system pressures to equalise before restarting.

Moving your refrigerator

- On Ice & Water model refrigerators disconnect the water supply.
- Turn off the appliance and unplug from the power point. Remove all food.
- Turn the adjustable feet to the right as far as they will turn (refer to page 9).
- Ease the refrigerator out of its position. Tuck the power cord away and tape the doors closed. Tape the shelves in place. If the cabinet needs to be placed at an angle or laid down, carefully lay it on its side (the right hand side when viewed from the front).
- Relocate and install. If the appliance has been left on its side for any length of time, leave it standing upright for at least 10 minutes before turning on.

Storing your refrigerator

- When storing your cleaned appliance, leave the doors open. This allows air to circulate and prevents the build-up of bacteria and moulds.
- Before using again, clean well using a mixture of warm water and liquid dishwashing detergent or baking soda (add 1 teaspoon of baking soda to every 500 ml of water). Rinse with clean water.

Holiday time

We recommend you leave your refrigerator operating while you are on holiday.

Door conversion (Non Ice & Water models only)

If you need to hinge your door on the opposite side we recommend that you call your local Fisher & Paykel Authorised Service Centre or Dealer to make this conversion. *Active Smart™* refrigerators with silver handles need to be ordered either with left or right opening doors and can not be interchanged. All other models need to have an appropriate conversion kit for your model refrigerator. The kit is available from your Authorised Service Centre or Dealer. Full instructions are included in the conversion kit.

Models:	635 mm wide	E402B
	680 mm wide	E442B
	790 mm wide	E522B

For information on the operation of the Ice & Water control panel please refer to page 15.

Temperature control

- When the refrigerator is first turned on, the powerful cooling system will automatically cool both refrigerator and freezer compartments to their set temperatures. This will take between 2 – 3 hours depending on the temperature and humidity of the environment.
- The two compartment temperatures are accurately and independently controlled and do not change with the temperature or humidity of the surroundings; whether summer or winter.
- If you wish to alter the temperature of either the fresh food or freezer compartment, this can be easily done by using the control panel located at the back of the fresh food compartment.

Control panel To adjust temperatures

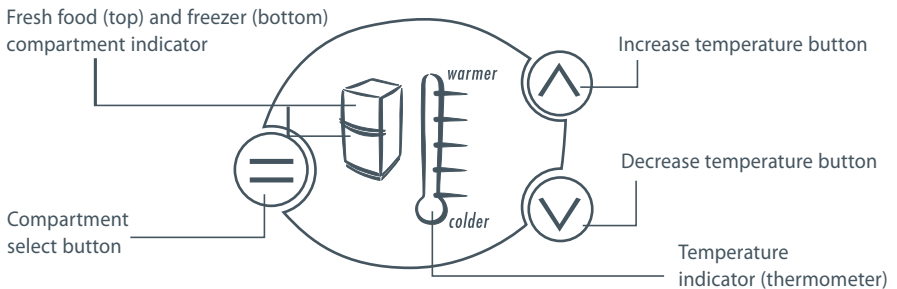

Fig.7 Non Ice & Water control panel

Fresh food compartment

- The fresh food compartment light on the refrigerator diagram will be showing. The temperature indicator illustrated by a thermometer will show the temperature setting for this compartment as a series of lights.
- The temperature may be altered by pressing the \blacktriangle or \blacktriangledown buttons. One press on either of these buttons will produce a dimmer light which indicates a small change in temperature.
- Pressing either button twice gives a brighter light and indicates a greater change in temperature. Fewer lights on the thermometer means a cooler temperature for the compartment selected.

Freezer food compartment

- To adjust the freezer temperature press the **≡** button until the light flashes on the freezer compartment indicator.
- The freezer temperature can be altered by pressing the **∧** or **∨** buttons.
- One press on either of these buttons will produce a dimmer light which indicates a small change in temperature. Pressing either button twice gives a brighter light and indicates a greater change in temperature.
Note: Successively pressing the **≡** button will automatically select between the compartments, a return to the fresh food compartment will be accompanied by a longer beep.
- When the door is reopened the control panel will return automatically to the fresh food compartment setting.

Sabbath mode

- To activate the Sabbath mode press and hold the **≡** button on the temperature control panel for 10 seconds.

When the product is in Sabbath mode:

- The light will not operate when the door is opened.
- The door alarm will not operate.
- The display will not be illuminated.
- Opening the door will not affect the compressor or fans.
- If the power to the refrigerator is turned off whilst in this mode, the product will continue in Sabbath mode when the power is restored.
- Sabbath mode will automatically de-activate 80 hours after activation.
- To de-activate earlier than 80 hours press the compartment select button on the temperature control panel for 10 seconds.

Fault alarms



- If the electronic controller detects a fault from which it is unable to recover an alarm will sound.
- When the fresh food compartment door is opened a fault code (specific pattern of lights) will flash red and green on the Control panel to alert you to the fault. The audible alarm will stop when any button is pressed but the lights will remain flashing. If such a fault occurs, call your Fisher & Paykel Appliances Authorised Service Centre immediately; the fault code will help the service person find and remedy the cause of failure.

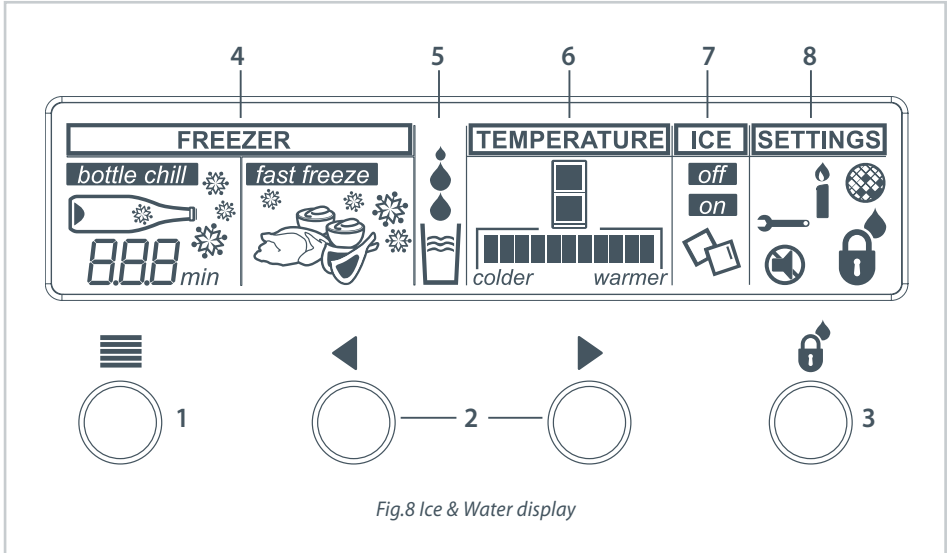













The display screen enables you to view and modify all the features and options on your refrigerator. For example, you can change the temperature in your refrigerator or freezer, and select the Fast Freeze function when you want to quickly freeze meat. You may want to also quickly chill a bottle of wine when friends arrive unexpectedly.



Keys

For more detailed information on these functions please refer to pages 17 – 23.

	<p>1. Main menu</p> <p>Scrolls through the main menu. (Freezer, Temperature, Ice and Settings).</p>
	<p>2. Arrow keys</p> <p>Scrolls through the settings of each function.</p>
	<p>3. Key and Dispenser Lock</p> <p>Dispenser Lock – disables the buttons and prevents water from being dispensed.</p> <p>Key Lock – disables the buttons.</p>

	4. Freezer (refer to pages 17 – 18)
	Bottle Chill Your drinks can be chilled more rapidly using this function. An alarm will alert you when they are ready (refer to page 17).
	Fast Freeze When activated this feature boosts cooling in your freezer, optimizing the rate at which your foods are frozen (refer to page 18).
	5. Dispensing water (refer to page 21) Animation shows you water is being dispensed.
	6. Temperature (refer to page 18)
	The temperature setting can be individually adjusted for each compartment.
	7. Ice (refer to pages 23 – 24)
	The ice making function can be turned on or off.
	8. Settings/User alerts (refer to pages 19 – 20)
	Key Silent mode All key presses can be silenced (refer to page 19).
	Dispenser and Key Lock Dispenser Lock – disables the buttons and prevents water from being dispensed (refer to page 19).
	Key Lock – disables the buttons (refer to page 19).
	Sabbath mode Can be activated if necessary (refer to page 19).
	Filter reset If you install a water filter to your water system, the filter icon will appear when the water filter needs changing (refer to page 22).
	Service/Fault Diagnosis If a fault occurs, the fault icon and fault code will be displayed on the screen (refer to page 20).

Using the display options



This function allows you to chill your beverages in the freezer without the worry of forgetting about them.















When activated, place your beverage into the freezer and after the set time has elapsed, Bottle Chill will remind you to remove your beverage by sounding an alarm. The user alarm will continue to sound until any key on the panel is pressed.

The time taken to chill depends on the size of your beverage. Bottle Chill allows you to customise this chill time.

Recommended times:

- 20 minutes – can or small bottle
- 25 minutes – wine bottle or similar size beverage
- 30 minutes – larger bottle

If you remove your beverage from the freezer and it is not chilled to your liking, reset the timer to 10 minutes and place the beverage back into the freezer.

- To activate, use  button until the Bottle Chill icon () is showing on the  screen. Then use the  or  buttons until the snowflakes () and the minute timer () are displayed on the Bottle Chill screen.
- Then use the  button to select 10, 15, 20, 25 or 30 minutes as displayed on the Bottle Chill screen. After several seconds, the snowflakes will then animate as the timer counts down.
- An alarm will sound after the amount of time selected has elapsed.
- Press any button on the display to silence the alarm. Remember to remove the beverage from the freezer.
- To deactivate Bottle Chill manually, use the  button to scroll to the Bottle Chill icon () on the  screen, then use the  and  buttons until no minutes are shown on the screen and the snowflakes () are no longer visible.

Important!

Do not leave the bottle inside the freezer longer than the time needed for chilling, as glass bottles may explode.

Using the display options

fast freeze



Fast Freeze

We have created the Fast Freeze feature to help you to get the best possible results when freezing fresh food. Fast Freeze boosts the freezing speed, which helps to ensure vital freshness, texture and taste are retained during the freezing process.

The Fast Freeze feature drops the freezer to its coldest temperature for a 12 hour period and then returns to its normal mode. You may wish to use this when freezing a quantity of meat or when making frozen desserts.

- To activate, use the button until the Fast Freeze icon () is showing on the **FREEZER** screen. Then use the or buttons until the snowflakes () are displayed on the Fast Freeze screen. The animating snowflakes indicate that Fast Freeze has been activated.
- To deactivate the function manually, use the button to scroll to the Fast Freeze icon () on the screen. Then use the and until there are no snowflakes () present on the screen.

For best results, we recommend that you activate the function approximately 2 hours before it is required. Alternatively, activate it when placing food into the freezer.

Note: The Bottle Chill and Fast Freeze option cannot be used at the same time.

The temperature of your refrigerator and freezer

- When the refrigerator is first turned on it will take approximately 2 to 3 hours to cool, depending on the humidity and temperature of the environment.
- To adjust the temperature of a compartment, use the button to scroll to the **TEMPERATURE** screen, use the button to select the compartment you want to change.
- The temperature can then be adjusted using the button to make the compartment warmer or the button to make the compartment colder.
- The temperature setting will be indicated on the icon below.

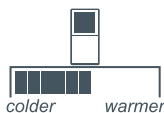





It is important to have your refrigerator set to the correct temperature. Setting it too cold may cause some items in the refrigerator to freeze, and setting it too warm will decrease the storage life of your food.

- For further information on food storage refer to the Food Care section (pages 33 – 35).

Using the display options





Settings

Key Silent mode

- The Key Silent Mode allows you to silence all key presses.
- It can be activated or deactivated by using the  button to scroll to the **SETTINGS** screen and then pressing the  or  buttons.
- When the Key Silent Mode is on  will appear.
- When this function is off  will appear.

Note: Faults, Bottle Chill timer and the door alarm will still sound when the refrigerator is set on Key Silent Mode.

Dispenser and Key Lock

- The Dispenser Lock disables the buttons and prevents water from being dispensed.
- Key Lock disables the buttons.
- Activate by holding down  on the display panel.
- After 2 seconds  icon will appear indicating Dispenser Lock is activated.
- After 2 more seconds  will appear indicating Key Lock is activated.
- To de-activate, hold down  on the display panel for 2 seconds.

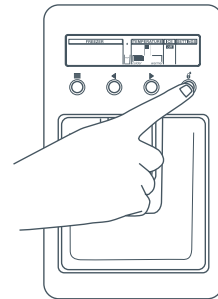





Fig.9 Dispenser and Key Lock

Sabbath mode

- In Sabbath mode alarms, lights and displays are deactivated.
- Sabbath mode can be activated or deactivated by holding down the , ,  buttons for 4 seconds.

Once in Sabbath mode:

- The interior light will not turn on when the refrigerator is opened.
- The door alarm will not operate.
- The display will not be illuminated.
- Electronic control panel will not work.

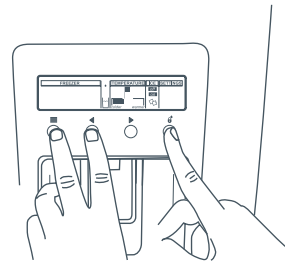

Fig.10 Sabbath mode



Note: If power is turned off the refrigerator will automatically continue in Sabbath mode once power is restored. Sabbath mode will automatically de-activate after 80 hours.

Using the display options

User warnings

Your refrigerator is clever enough to diagnose its own problems. It will alert you when there is a fault.

Fault

- In the unlikely event a fault occurs the  icon appears on the front of the display and a fault code will be displayed on the left in the  screen.
- When the door is open the refrigerator fault alarm will sound. To silence this press any button on the display.
- Please take note of the fault code and contact our Customer Care Centre. Details of Customer Care phone numbers can be found in the back of this book.

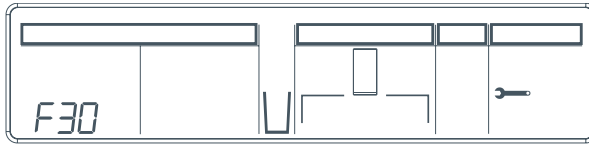



Fig.11 Fault code display

Filter reset

If you install a water filter, the filter reset icon  will appear when the water filter needs changing. This will flash when dispensing water. To reset or disable (if no filter fitted) the filter icon refer to page 22.

Dispensing pad

Your water dispenser has been designed for one handed operation. Simply push your glass up against the dispenser pad located at the back of the dispenser area. This pad requires only a gentle press to activate.

Please remember that pressing very hard against the dispensing pad will not make the dispenser operate faster or produce greater quantities of water.

First use

- After installation, on the first use, allow approximately a one minute delay while the dispensing pad is pushed until water is dispensed. This will allow the tank to fill completely.
- After you fill the tank for the first time, dispense and discard approximately 8 – 10 L stopping intermittently to flush the tank out.



Dispensing

- To dispense water push the dispensing pad gently, using a glass or container.
- When you dispense water, a light will appear above the dispensing area, and on the display screen. The water fill icon  will also appear.
- To stop the flow of water, simply pull your glass away from the dispensing pad.

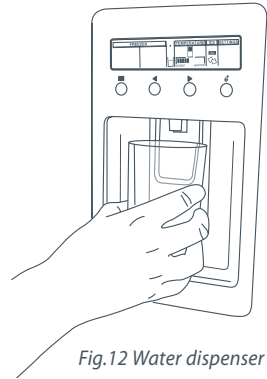



Fig.12 Water dispenser

Important!

To avoid damage to property or personal injury do not put hands, fingers or objects up the dispenser opening.

Please note that once installation is complete a few drips may appear out of the dispenser over the next few days as the remaining trapped air is cleared.

22 Water filter (Ice & Water models only)



- Contact an authorised plumber if you want to install a water filter in the water system.
- If you choose to install a water filter, this will need changing approximately every 6 months.
- There is a replacement indicator icon  on the control panel which will appear when the filter needs replacing. It will flash, as a reminder, when water is dispensed.

To reset the filter indicator





Important!

We recommend a water filter is used from the point of installation.

Do not reset indicator before filter is changed or filter monitoring will be inaccurate.

- Press and hold  and  buttons for 4 seconds to reset the filter indicator.
- If the filter is present the  icon in the **SETTINGS** screen will disappear when reset.

To disable the filter indicator

- When no filter is fitted, you can disable the filter indicator.
- Press and hold ,  and  buttons for 4 seconds to turn this feature off/on.
- When activated or deactivated the  icon will flash and on or off will be displayed on the **FREEZER** screen.
- We recommend you do not disable the filter indicator if you have a filter fitted, as you will not be reminded to change your filter.

Important!



- *To avoid serious illness or death, do not use the water filter where water is unsafe or of unknown quality without adequate disinfection before or after use of filter.*
- *The water filter cartridge needs to be changed when the filter indicator icon flashes on the interface panel.*
- *We recommend the water filter cartridge is replaced when the  icon flashes. This will happen every 6 months.*
- *If the water filtration system has been allowed to freeze, replace filter cartridge.*
- *The rate of water flow through the water dispenser can slow down as the filter cartridge accumulates any sediment which may be present in the water supplied to your home. This varies depending upon your local water quality, which may require your filter cartridge to be changed more frequently.*
- *In cases of excessively reduced filter life we recommend that you consult a local plumber or your water supplier for advice on suitable filtration requirements for the water supplied to your home.*
- *Filter replacement is the consumer's responsibility and will not be covered by the warranty except in the case of faulty parts or materials within the filter cartridge.*
- *If the water has not been dispensed for some time or water has an unpleasant taste or odour, flush system by dispensing 10 L of water.*
- *If unpleasant taste or odour persists, you may wish to fit a new filter cartridge.*

on

Ice maker

Your ice maker is designed to automatically dispense ice until it senses that the bin is full. So the more ice you use, the more it makes. It is even clever enough to sense when there is no bin in place to catch the ice.



First use

- When you first turn your refrigerator on after installation, the ice maker will be off.
- To turn your ice maker on use the  button to scroll to the **ICE** screen. Use the  or  button to turn the ice maker on or off.

on

 Shows the ice maker is on.

off Shows the ice maker is off.

- Press    together to force a cycle. The ice tray will flip. Force another cycle. The ice tray will flip and spill the water into the ice bin. Empty water and replace bin.
- If the bin is full, or inserted incorrectly the ice maker will not operate. When the bin is inserted correctly the scoop will be on the right hand side of the bin for models E402B, E442B, E522B and the front of the bin for model RF610A (refer to Fig.14 on page 24). If all bins are removed the ice maker will not operate.
- Once your ice maker is in operation, discard the first bin of ice cubes. This will flush away any impurities in the water line and ensure that you get the best quality ice. We recommend that you also do this after vacations or extended periods of not using ice.
- We recommend that you turn the ice maker off if:
 - The water supply is to be off for several hours or
 - The ice storage bin is to be removed for a period of time or
 - You are going on holiday/vacation.

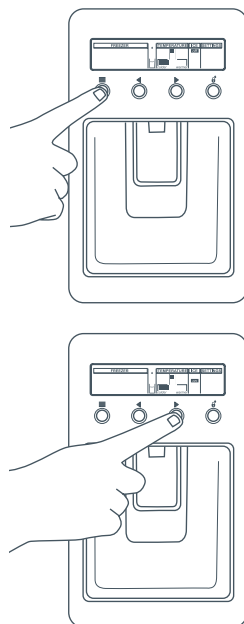
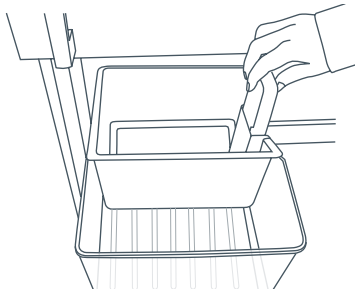

Fig.13 Turning ice maker on

Information about your ice maker

- Your automatic ice maker will produce approximately eight cubes of ice every 2 – 3 hours, dependent on freezer compartment temperature and number of door openings.
- The ice cube tray will fill with water once the freezer has reached the correct temperature. The first cubes will normally freeze after several hours.
- When cubes are frozen, they will be ejected from the mould into the ice storage bin.
- Ice making will continue until the storage bin is full.
- Ice making will resume when the ice is used.
- For maximum ice storage, level the stored cubes with the ice scoop provided.
- Your Ice & Water product comes with a smaller ice bin inside the larger freezer bin. Attached to this is the scoop for the ice. This scoop provides hygienic access to the ice.
- If a large amount of ice is required, remove the smaller storage bin and allow ice to fall into the larger bin.
- If ice is not used often, old cubes will become cloudy, taste stale, will shrink and may stick together. Empty the ice storage bin periodically, wash in lukewarm water, dry thoroughly and place back in the correct position.



E402B, E442B, E522B

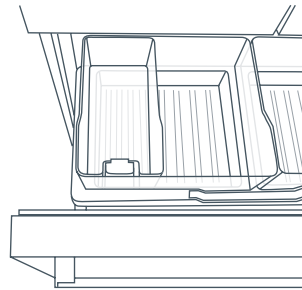

RF610A

Fig.14 Ice storage bin and scoop in correct position

Important!

- *Avoid contact with the moving parts of the ice maker ejector mechanism, and do not place your fingers on the automatic ice making mechanism while the refrigerator is in operation.*
- *Do not use ice cubes that may have become discoloured, usually with a green-blue colour. If such discolouration is noted, discard the ice cubes and contact your Fisher & Paykel Appliances Authorised Service Centre.*
- *Ensure the ice maker is connected only to a drinkable water supply (and filter if fitted).*
- *Installation of the water connection to the ice maker must be completed by a qualified service technician or a qualified plumber (see installation instructions).*

Fruit and vegetable bins and humidity control cover

The fruit and vegetable bins feature a unique cover which provides two functions:

- The humidity cover seals the bins and provides a humid microclimate to extend storage times of fruit and vegetables.
- The humidity cover prevents condensation, which forms at high humidities, from dripping down onto the fruit and vegetables. The ability to retain high humidity in the fruit and vegetable bins may mean small amounts of water will pool in the bottom of the fruit and vegetable bins. This can be wiped out as required.

Fruit and vegetable bins and humidity slide (where fitted)

- Each fruit and vegetable bin has a humidity slide control that can be adjusted to a fruit or vegetable setting depending on what is stored in the bins.
- If possible try to store fruit and vegetables separately. This will help extend their storage life.
- If there is a mixture of fruit and vegetables in the bin adjust the position of the control to the centre.
- If there is too much water in the bins the control can be adjusted towards the setting with fewer drips (fruit setting).
- Remember a small amount of water in the bins is beneficial for fruit and vegetable storage.

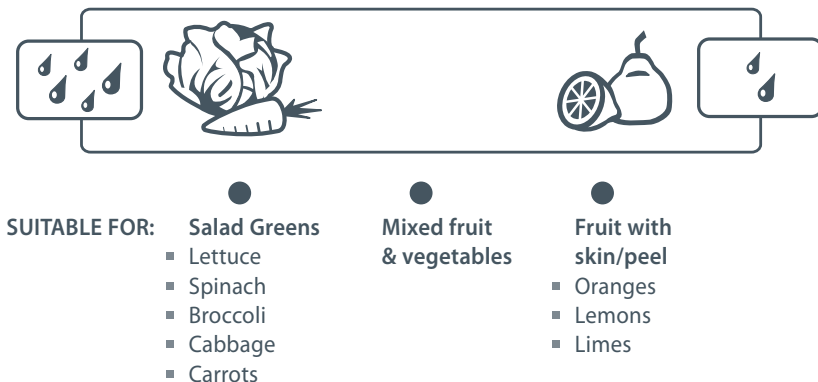

Fig.15 Humidity Control graphic

Ice trays and lid (where fitted)

- To empty the ice cubes into the lid, hold the tray and lid together and twist to dislodge.
- Refill the ice tray with water, place lid containing ice cubes on top and store in the freezer.
- Ice cubes are best stored in a closed container or plastic bag as they readily absorb odours and tastes from other foods.

Slim storage drawer (where fitted)

The bins at the bottom of the refrigerator provide storage space for items that you may want to keep separate from the rest of the refrigerator. These slim storage bins can be used for deli item storage, beverages or for defrosting foods.

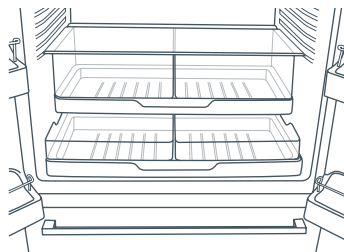

Fig.16 Slim storage drawer

Door alarms

- If the fresh food compartment door is left open the alarm will beep after 90 seconds and if the freezer door is left open the alarm will beep after 60 seconds.
- While either door remains open, subsequent beeps will sound every 30 seconds for 5 minutes.
- A continuous alarm will sound if either door has been left open for 5 minutes or longer and the light will turn off. The alarm will stop when the opened door is closed.

Bottle rack (where fitted)

- The bottle rack can be used to store a variety of bottles and can be positioned anywhere you would position a shelf. To re-position, lift the rear of the rack and pull forward. Bottles are best stored with the neck of the beverage facing the front of the refrigerator.

Drip tray (Ice & Water only)

- The drip tray is designed to fit into the lip at the bottom of the water dispenser panel.
- To insert the tray always ensure that the rounded sides are fitted into the dispenser panel first.
- The purpose of the tray is to capture any odd drips of water that may fall after dispensing.
- The tray can be easily removed for cleaning (see page 28).

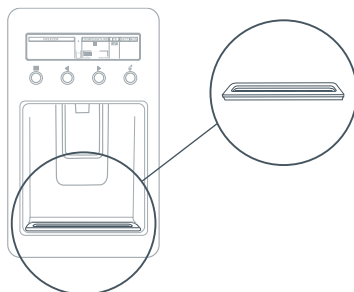

Fig.17 Drip tray

Glass shelves

- Glass shelves can be re-positioned in the cabinet as desired.
- Remove by lifting up at the back and pulling forward.

Replacement of the interior light (Halogen light bulb)

Turn the power off at the wall socket before replacing the bulb. The light bulb is located on the top roof of the cabinet at the front.

- Remove the lens cover using a small screwdriver. Insert the screwdriver in the front centre of the lens cover and gently lever down. Pull out old bulb.
- Do not touch the new bulb with your hand. Leave it in the plastic bag whilst slotting into position.
- Remove plastic bag when bulb is in position.
- Replace lens cover.
- Turn power on. Light bulb should now glow.

Note: the replacement halogen bulb must not exceed 12 Volt/10 Watt. Bulbs are available from your Fisher & Paykel Appliances Customer Care Centre.

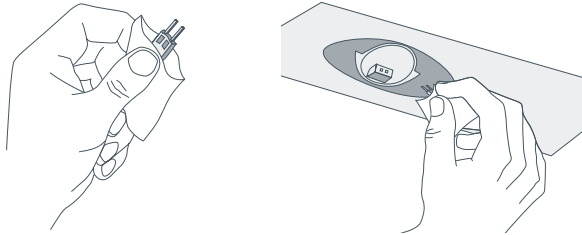

Fig.18 Halogen light replacement

Important!

Your refrigerator is designed to operate for many years without the need for service checks. However, if your refrigerator is malfunctioning, have it attended to by your Fisher & Paykel Appliances Authorised Service Centre as soon as possible. All electrical repairs must be carried out by an adequately trained service technician or qualified electrician.

Exterior

Stainless exterior doors (Iridium or EZKleen finishes)

- It is important when cleaning the exterior door surface of your refrigerator, to only use liquid dishwashing detergent dissolved in warm water and a soft cloth.
- Dry the door with a clean, lint free cloth.
- The use of any abrasive or stainless steel cleaners and solvents will damage the door surface.

Other exterior surfaces

- Clean all other exterior surfaces with a mix of warm water and detergent and a soft cloth.
- If necessary, clean the magnetic door gasket and the centre door gaskets with an old toothbrush, warm water and liquid dishwashing detergent.

Water evaporator tray

- The water evaporator tray is found above the compressor at the back of the refrigerator. The tray may require infrequent cleaning.
- Carefully move the refrigerator out from the wall.
- Switch off the appliance.
- We do not recommend that you remove the evaporator tray. If cleaning is required, excess water can be soaked up from the evaporator tray using a sponge. Wipe out with warm water and detergent or disinfectant.
- Reassemble taking care not to over-tighten the fasteners.
- Switch on the appliance.



Water dispenser pad and interface (Ice & Water models)

- We have incorporated a Dispenser and Key Lock function in your refrigerator to make cleaning easier (refer to page 19). This will help you to avoid accidental water dispensing while you clean.
- Clean the pad and interface panel with a soft damp cloth.

Drip tray (Ice & Water models)

- To clean, take the tray out of the dispenser panel and pull the two halves of the tray apart.
- Clean in warm water with a mild detergent. Dry the tray and clip back together.
- Re-insert the tray back into the dispenser panel.

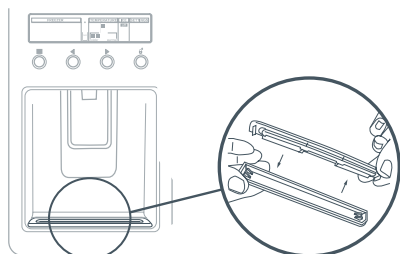

Fig.19 Drip tray removal

Interior

- It is important to keep the interior of the refrigerator and freezer clean to help prevent food from becoming contaminated during storage.
- The amount and types of food stored determines how often cleaning should be carried out in the refrigerator (ideally once every 1 to 2 weeks).
- Remove the shelves from cabinet and door. Wash shelves and storage bins in warm water and detergent; rinse in clean water and dry before replacing.
- Wipe over the interior surfaces with warm water and detergent or baking soda dissolved in warm water (add 1 teaspoon of baking soda to every 500 ml of water). Rinse with clean water.
- To help remove “old stale refrigerator” smells add a few drops of vanilla essence or vinegar to the water before cleaning.
- Clean exterior surfaces with warm water and detergent. Use a toothbrush for the magnetic door gasket.
- Do not use harsh, abrasive cloths or cleaners or highly perfumed, strong smelling cleaners or solvents on any part of the refrigerator or freezer.

Glass shelves

- Clean with warm water and detergent.

Bottle rack

- Clean with warm water and detergent. The use of abrasive cleaners and solvents may cause damage.

Automatic ice dispenser (Ice & Water models)

- We do not recommend you clean the ice maker componentry, but it is important to clean the bins occasionally.
- The storage bin should be cleaned regularly and the old ice in the bottom of the bin discarded.
- Wash bin in lukewarm water, dry thoroughly and replace.
- When replacing the bin ensure that the scoop is on the right hand side, on E402B, E442B and E522B models and at the front on RF610A.

Important!

Many commercially available cleaning products contain solvents that may attack the plastic components of your refrigerator and cause them to crack. It is important to use only warm water and a small amount of liquid dishwashing detergent on any plastic components inside and outside your refrigerator. Avoid using anti-bacterial cleaning products on either the interior or exterior of the cabinet as they may cause rusting of metal components and cracking of plastic components.

Humidity Control System

Important!

When cleaning the shelf above the vegetable bins, we recommend that you do not disassemble the Humidity Control System from the shelf.

In the event that the plastic lid and humidity slides become separated from the glass shelf, follow these instructions to reassemble.

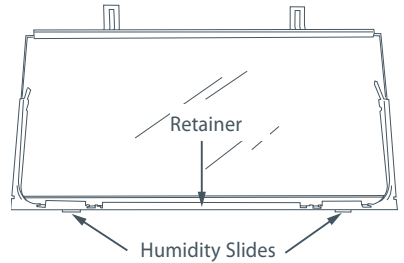

- 1 Turn shelf upside down.
- 2 To attach humidity slides onto shelf front corners, fit bottom clips into shelf front trim. Next, slide sideways towards shelf until arm clips onto glass.

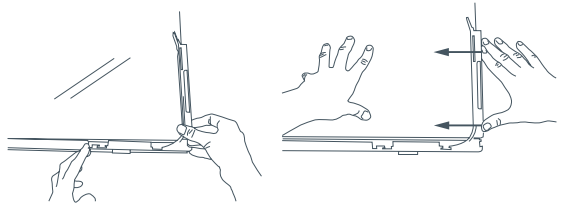

- 3 To attach humidity control lid – with text facing you, align lid with front of shelf. Hold lid vertically and fit front end into retainer on shelf. Ensure lid fits into retainer as well as underneath humidity slides.

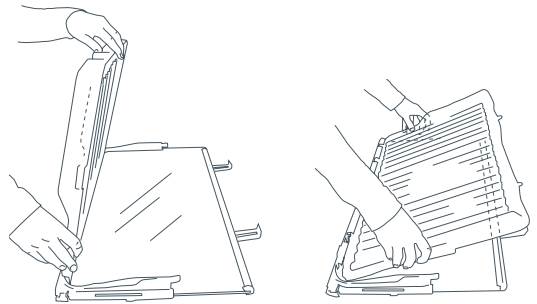

- 4 At the sides of the shelf, adjust humidity slide tabs so that the plastic lid is between the shelf and the tabs.
- 5 If clips on back of shelf are present, fasten lid with rear clips. Ensure that the cover is fully secure at front and back of shelf.

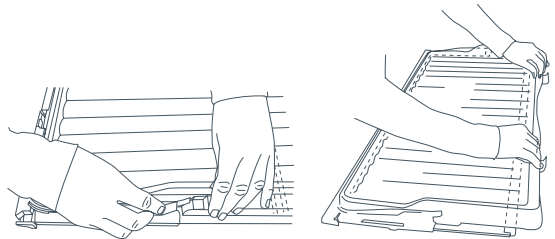

Fig.20 Humidity Control System cleaning

To remove trays or fixed bins

- For ease of removal, empty food from tray/bin first.
- Hold the centre front of the tray/bin handle.
- Lift vertically to unclip from the runners and pull tray/bin towards you to remove.
- Push both runners back into refrigerator.

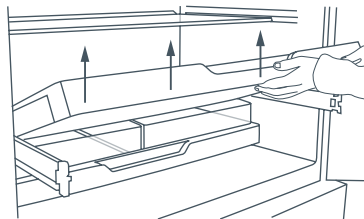

Fig.21 Tray removal

To replace trays or fixed bins

- With the runners pushed back into the refrigerator, place the tray/bin on top of the runners. Push the tray/bin back slowly until you feel it clip back onto the runners.

Important!

- *Ensure that trays and bins are securely clipped onto the runners before use.*
- *Bin and tray runners are pre-lubricated, and will not need to be re-lubricated during their life. Do not attempt to clean grease from the runners, as this will affect their ability to function. Do not immerse runners in water.*

Permanently fixed bins and trays (model RF610A only)

The large bottom freezer bin and trays in this model are permanently fixed. They cannot be removed from the freezer compartment. To clean simply wipe with a soft, damp cloth.

On vacation/holiday

We recommend you leave your refrigerator operating while you are on holiday.

Ice & Water models

- Switch the ice maker to off on the interface panel (refer to page 23).
- Shut off the water supply to the refrigerator.
- On your return, turn on the water supply to the refrigerator.
- Dispense 10 L of water and discard to ensure the tank is refilled with fresh water.
- Turn on the ice maker (refer to page 23).
- Throw away the first bin of ice cubes.

Normal refrigerator sounds

Active Smart™ refrigerators, with their excellent energy ratings and cooling performance, can produce sounds somewhat different to your old refrigerator.

Normal operational sounds include:

- Fan air flow sound. *Active Smart™* refrigerators have fans which change speed depending on demand. During cooling periods, such as after frequent door openings, fans circulate the cold air in the refrigerator and freezer compartments producing some air flow sound. This is quite normal.
- Cracking or popping which may sound like ice coming off the evaporator. This occurs when the defrost function is operating.
- Running water sound. This is the liquid refrigerant in the system and can be heard as a boiling or gurgling noise.
- An audible hissing sound after closing the freezer door. This is due to the pressure difference between the warm air that has entered the cabinet and suddenly cooled, and the outside air pressure.
- Other strange sounds may be heard for the following reasons:
 - Cabinet not level
 - Floor uneven or weak
 - Bottles or jars rattling on shelves
- If this is your first refrigerator with an ice maker, you will hear occasional sounds that may be unfamiliar. They are normal ice making sounds and are not cause for concern.
- The following sounds are normal with the operation of an ice maker:
 - Motor operation (low humming).
 - Running water as the ice maker and/or water tank fills.
 - Water valve opening and closing (hissing sound).
 - Ice being loosened from the ice moulding tray (cracking).
 - Ice dropping into bin (clunking).

Red meat

- Place fresh red meat on a plate and loosely cover with waxed paper, plastic wrap or foil.
- Store cooked and raw meat on separate plates. This will prevent any juices lost from the raw meat contaminating the cooked product.
- Delicatessen meats should be used within the recommended storage time.



Poultry

- Fresh whole birds should be rinsed inside and out with cold running water. Dry and place on a plate. Cover loosely with plastic wrap or foil.
- Poultry pieces should also be stored this way. Whole poultry should never be stuffed until just before cooking, otherwise food poisoning may result.
- Cool and refrigerate cooked poultry quickly. Remove stuffing from poultry and store separately.



Fish and seafood

- Whole fish and fillets should be used on the day of purchase. Until required, refrigerate on a plate loosely covered with plastic wrap, waxed paper or foil.
- If storing overnight or longer, take particular care to select very fresh fish. Whole fish should be rinsed in cold water to remove loose scales and dirt and then patted dry with paper towels. Place whole fish or fillets in a sealed plastic bag.
- Keep shellfish chilled at all times. Use within 1 – 2 days.

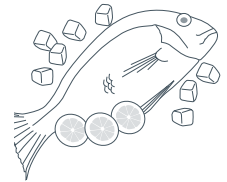

Precooked foods and leftovers

- These should be stored in suitable covered containers so that the food will not dry out.
- Keep for only 1 – 2 days.
- Reheat leftovers only once and until steaming hot.

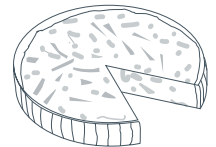

Fruit and vegetable bins

- Although most fruit and vegetables keep best at low temperatures, take care not to store the following at temperatures of less than 7°C for long periods: citrus fruit, tropical fruit, tomatoes, cucumbers.
- Undesirable changes will occur at low temperatures such as softening of the flesh, browning, accelerated decaying and or loss of flavour.
- Do not refrigerate avocados (until they are ripe), bananas, mangoes or pepinos.
- If possible store fruit and vegetables separately, ie fruit in one bin and vegetables in the other.
- Each fruit and vegetable bin has a humidity control slide that can be adjusted depending on what is stored in the bins. For more information on using the Humidity Control refer to page 25.

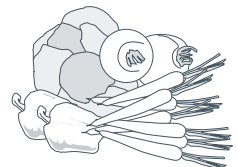

34 Storing food in your freezer (all models)

The use of temperatures of -18°C or colder to store food means that the food can be kept for longer periods than when refrigeration temperatures are used. This is because the growth of bacteria, moulds and yeasts are stopped, and chemical and physical reactions are severely restricted at such low temperatures.

Frozen food care

For best results:

- Choose only high quality foods that freeze well.
- Store at -18°C or colder. Take care to maintain this low storage temperature, eg try to avoid opening the freezer door unnecessarily. If your ice cream is soft you are running your freezer too warm.
- Leave space at the top of containers, glass jars or plastic bags containing liquids or semi-solid foods. These expand as they freeze. Usually 20 – 50 mm head space is recommended. Seal. Ideally, remove all the air from the package after food is frozen.
- Packages or containers of solid foods should have the air removed from them and be sealed tightly before freezing.
- Use the Fast Freeze function when freezing fresh food. This helps to speed up the freezing process, giving optimum freezing results. It is recommended that the function is activated approximately 2 hours before required. For more information refer to page 18.
- Freeze immediately or as quickly as possible. Freeze only small quantities of food at any one time. For best results we recommend that only 1 kg of food be frozen per 25 L of freezer storage volume at any one time. (About 3 kg in small freezers and 4 kg in larger freezers). For faster freezing in *Active Smart™* models, we recommend that fresh food is placed at the top of the freezer compartment close to the air vent.
- Do not pile frozen food around the fan cover. It can prevent adequate air circulation.
- Thaw foods preferably in a refrigerator, or using a microwave oven or multifunction oven.
- Keep a constant turnover of food. Use older items of food first. Do not exceed recommended storage times.
- Use good quality freezer proof packaging to maintain food quality.
- If food is only covered in plastic film place inside a freezer-proof plastic bag.



Recommended freezer storage times

These times should not be exceeded.

	M o n t h s	1	Bacon, casseroles, milk
		2	Bread, ice-cream, sausages, pies – (meat and fruit), prepared shellfish, oily fish
		3	Non oily fish, shellfish, pizza, scones and muffins
		4	Ham, cakes, biscuits, beef and lamb chops, poultry pieces
		6	Butter, vegetables (blanched), eggs whole and yolks, cooked crayfish, minced meat (raw), pork (raw)
		12	Fruit (dry or in syrup), egg whites, beef (raw), whole chicken, lamb (raw), fruit cakes

Meat, poultry and game

- Do not try to freeze more than 1 kg meat per 25 L of freezer storage volume at any one time. Meat must be frozen quickly in order to maintain its texture.
- Do not stuff poultry before freezing.
- Red meat can be cooked from frozen, or from the partly or completely thawed states. Remember to allow extra cooking time if cooking from frozen.
- Always thaw poultry completely before cooking.



Fish and seafood

- Fish is best frozen commercially. If, however, you do want to freeze fish at home, make sure the fish is very fresh and of high quality.
- Clean, scale and preferably leave whole. All fish should be wrapped in two layers of packaging as depending on the type of fish, odours and flavours can be readily transferred either to or from it. Seal well.
- For best results, cook from either the frozen or partly thawed state.

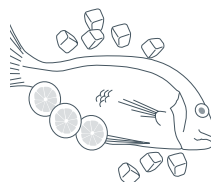

Vegetables

- Most vegetables freeze well, although 'salad' vegetables lose their crispness. Other vegetables, eg celery, onion and tomatoes, should only be used in cooked dishes as they soften on freezing.
- Freeze only high quality, mature, ready-to-eat vegetables.
- Sort and discard any vegetables that are damaged.
- **It is necessary to blanch most raw vegetables prior to freezing.**
- Blanching involves a short cooking period during which vegetable enzymes are destroyed. If these enzymes are not destroyed they cause undesirable physical and chemical changes during freezer storage.
- Vegetables can be blanched in boiling water, steam or microwave oven. If using boiling water, boil vegetables for 2 – 4 minutes and cool quickly.
- In general frozen vegetables are best cooked from their frozen state.

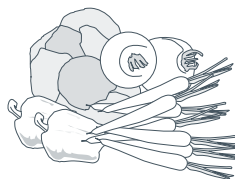

Prepared and cooked foods

- Most cooked foods can be frozen but it is not recommended to freeze the following:

Cooked egg white, custards, cream fillings and milk puddings, gelatin or jelly-like dishes, mayonnaise and similar salad dressings, meringue toppings. These tend to separate on thawing.

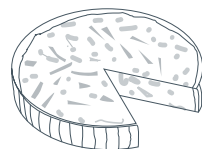

Fruit

- Choose high quality, mature, and ready to eat fruit. Preferably select varieties recommended for freezing.
- Avoid unripe and over-ripe fruit.
- The way fruit is packed depends on how it is to be used. Fruits packed in syrup are ideal for desserts, whereas fruits packed without sugar are better used for cooking. Most fruits can be stored for 8 – 12 months.





36 Troubleshooting (all models)

If there is a problem with your appliance, please check the following points before contacting your local Fisher & Paykel Appliances Authorised Service Centre Dealer or Customer Care Centre.

Problem	Possible causes	What to do
Appliance does not operate.	No electricity at power outlet.	Check that the plug is correctly connected and power switched on. Check another appliance at the same outlet. Check house fuse.
Light not working.	Blown light bulb(s).	Change light bulb(s) (refer to page 27).
	Refrigerator not working.	Check refrigerator is turned on at wall. If problem continues refer to page 42.
Light and display not working.	Product in Sabbath mode.	Refer to Sabbath mode page 14 Non Ice & Water models and page 19 for Ice & Water models.
Motor operates for long periods.	Hot weather. Frequent door openings. Large amount of food recently added.	Minimise door openings to allow temperature to stabilise.
	Temperature control set too low.	See Temperature control section (page 13 for Non Ice & Water models and page 18 for Ice & Water models).
	Doors not sealing properly.	Check that cabinet is level and gasket seals are clean.
Storage compartments too warm.	Temperature setting not correct.	See Temperature control section (page 13 for Non Ice & Water models and page 18 for Ice & Water models).
	Frequent door openings. Large amount of food recently added.	Minimise door openings to allow temperature to stabilise.
Food freezing in the refrigerator.	Temperature setting not correct.	See Temperature control section (page 13 for Non Ice & Water models and page 18 for Ice & Water models).
	Food placed directly in front of air outlets.	Move chill sensitive foods away from the centre back of the shelves.
Unfamiliar noises.	Cabinet not stable or level.	See Installation section (pages 9 – 10) or refer to Sounds (page 32).
	Freezer is defrosting.	

Problem	Possible causes	What to do
Water in the vegetable bins.	Condensation is formed by the water produced by fruit and vegetables.	<p>A small amount of condensation is beneficial for fruit and vegetable storage. If there is too much water, store fruit and vegetables loosely in plastic bags.</p> <p>Wipe out water with a cloth.</p> <p>Set humidity slide to low humidity setting. </p>
Condensation on outside of refrigerator/freezer.	Not unusual during periods of high humidity.	Wipe dry.
Condensation inside fresh food compartment.	Frequent or long door openings.	Minimise door openings.
	Door gasket leaking.	Check that gasket is sitting flat and sealing tightly.
	Not unusual during periods of high humidity.	Wipe dry.
Ice build up inside freezer compartment.	Freezer door not closing tightly.	<p>Move items in freezer so door can close tightly.</p> <p>Check and clean door gasket seal.</p>
Door handles out of alignment.	With time and usage, movement may occur.	See Installation instructions – Stability instructions (pages 9 – 10).
Tray/bin does not slide in and out evenly.	Packaging trapped.	Check to ensure no food or packaging is trapped behind the tray/bin.
	Runners not extending fully.	Holding onto sides of tray/bin, extend the runners fully by using a firm pull – this will reset the runner.

Problem	Possible causes	What to do
Ice maker makes unfamiliar sounds or seems too loud.	Normal ice maker operation.	Refer to refrigerator sounds (refer to page 32).
Automatic ice maker does not work.	Ice maker has not been switched on.	Switch on ice maker (refer to page 23).
	Bin is in the wrong way or there is no bin in place.	Place bin so scoop is on the right side. Ice bin sits directly under ice maker on top left side of freezer.
	Water supply turned off or not connected.	Connect water supply.
	Freezer compartment not working.	Contact Customer Care.
	Water pressure too low.	Check water pressure.
	Water line kinked/squashed.	Check water line for kinks/squashing.
	Filter (if installed) clogged.	Water filter may need replacing (contact authorised plumber).
Ice cubes have odour/taste.	Unsealed packages may be transmitting odour/taste.	Old cubes need to be discarded. Ensure food packaging is sealed.
	Interior of freezer needs cleaning.	Ice storage bin needs to be emptied and washed. Clean refrigerator (refer to pages 29 – 31).
	Poor taste from incoming water.	Force 2 – 3 ice tray flips (refer to page 23). If fitted, a new filter may need to be installed (contact authorised plumber).
Slow ice cube freezing.	Door may have been left ajar.	Close door.
	Freezer compartment too warm.	Turn temperature to a colder setting (refer to page 13 for Non Ice & Water models and page 18 for Ice & Water models).
Warm spot on central door seal.	You may feel a warm spot at times on the central seal between the two refrigerator doors.	This is perfectly normal and is part of the normal refrigerator operation.

Problem	Possible causes	What to do
Wet ice/ ice clumping.	Low water pressure.	Check water pressure.
	Long freezer door openings. High ambient temperature. Ice bin left out of freezer compartment for a long length of time. Ice will stick together over time.	Gently tap ice with scoop to unstick or, if large clumps occur, empty ice bin and make new ice.
	Filter (if fitted) blocked.	Replace filter (contact authorised plumber).
Water has poor taste/odour.	Refrigerator not used for an extended period.	Dispense 10 L water so fresh water supply is replenished.
Water dispenser does not work.	Water supply turned off or not connected.	Turn water on. Press dispenser for 1 minute to remove trapped air from water line and to fill the water system.
	Supply line may be blocked. On first installation there may be air in water system.	Check supply for kinks or leaks. To remove air, run a litre or a quart of water through the dispenser.
	Water frozen in tank.	Increase temperature to a warmer setting in fresh food compartment and freezer.
	Dispenser lock activated.	Hold down the  button for 2 seconds.
	Filter (if fitted) may be blocked and need replacing.	Replace filter (contact authorised plumber).
Water in first glass is warm.	Water dispenser not used for extended period.	Discard first glass of water dispensed.
	Tank capacity used recently.	Allow water time to cool.
Filter warning light  is flashing.	Filter (if fitted) needs replacing.	Replace filter as soon as possible (contact authorised plumber).
	Filter indicator has not been disabled.	Disable filter indicator (refer to page 22) if filter not fitted.
Drips overflow drip-shelf.	Air trapped in tank.	Flush 3 L water through dispenser, stopping intermittently.
	New filter installed.	Flush 3 L water through filter and then 3 L through dispenser.
Water flow rate has slowed down.	Water line or filter (if fitted) is restricted.	Contact authorised plumber to check water system and/or replace water filter.

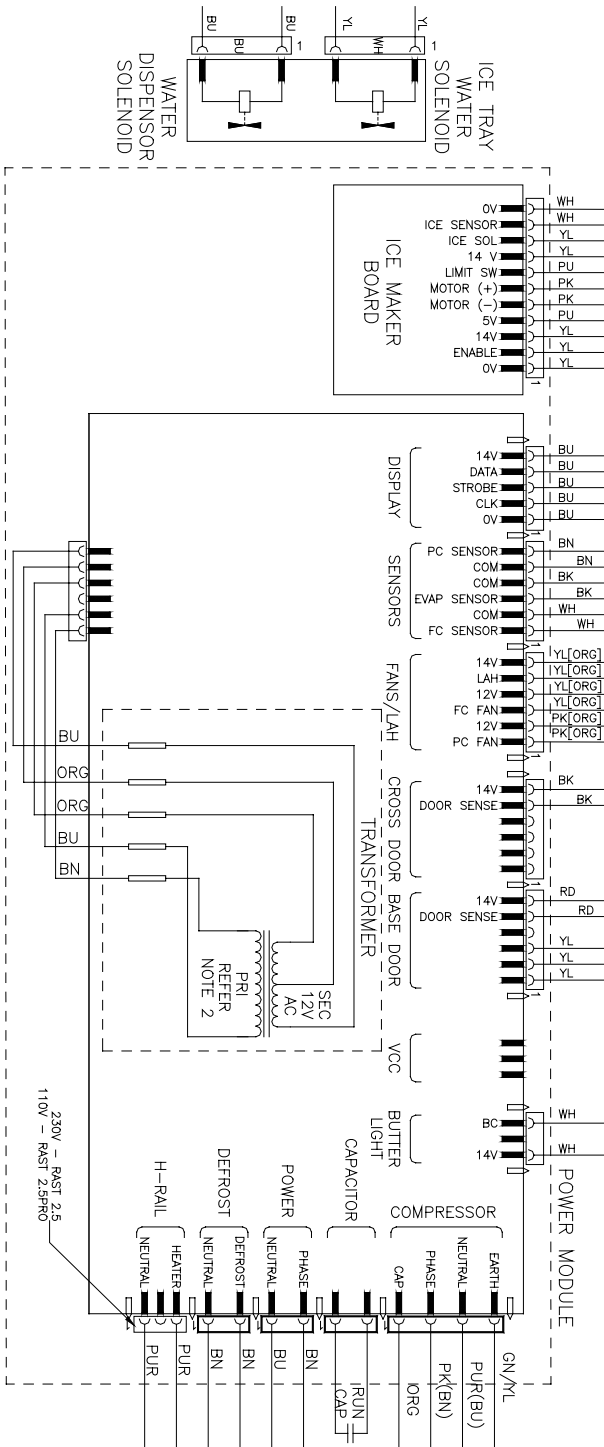

WIRING DIAGRAM ACTIVE SMART™ ST4 I&W
DGX OR EGZ COMPRESSOR

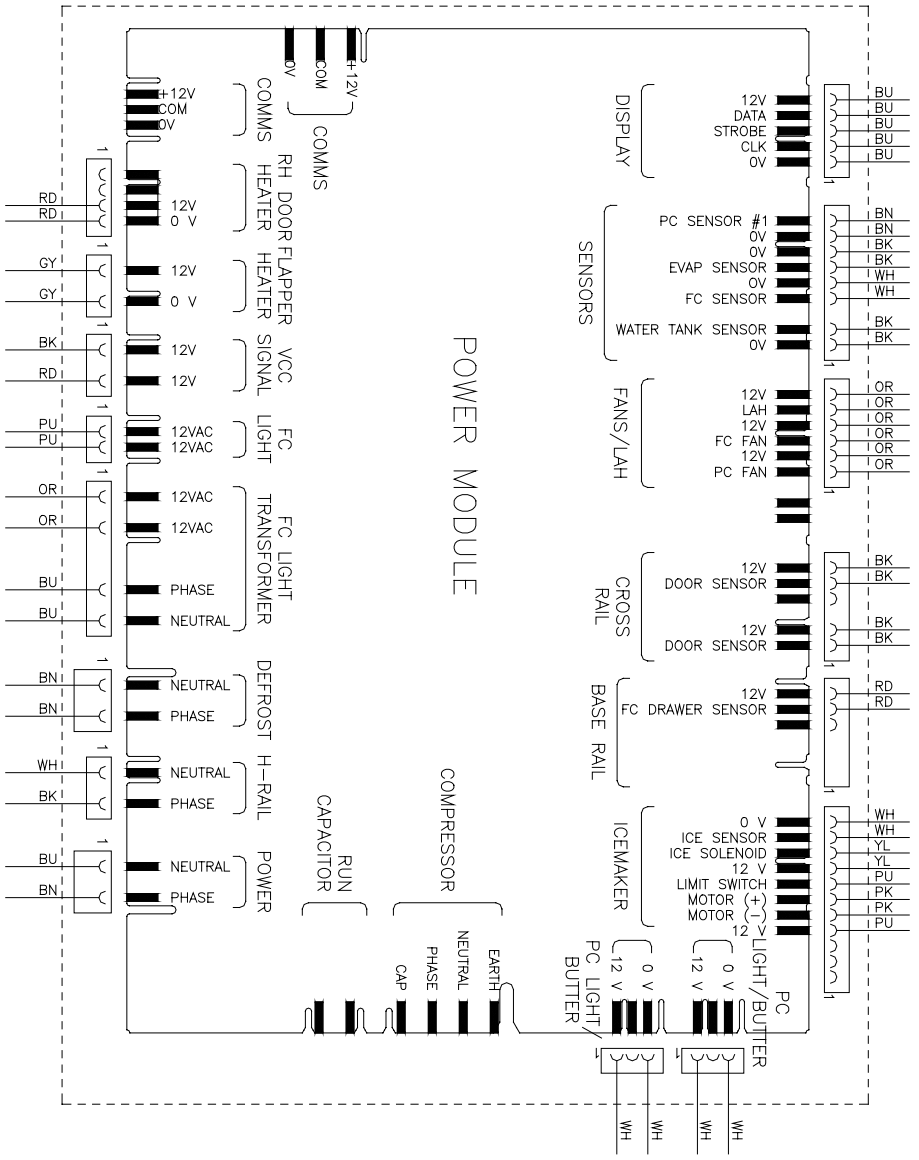
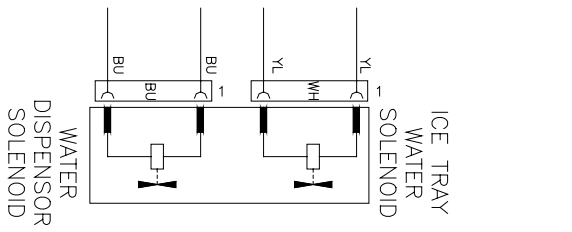
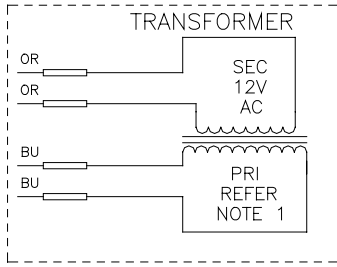

WIRING DIAGRAM ACTIVE SMART™ ST4 I&W
 DGX OR ERZ COMPRESSOR

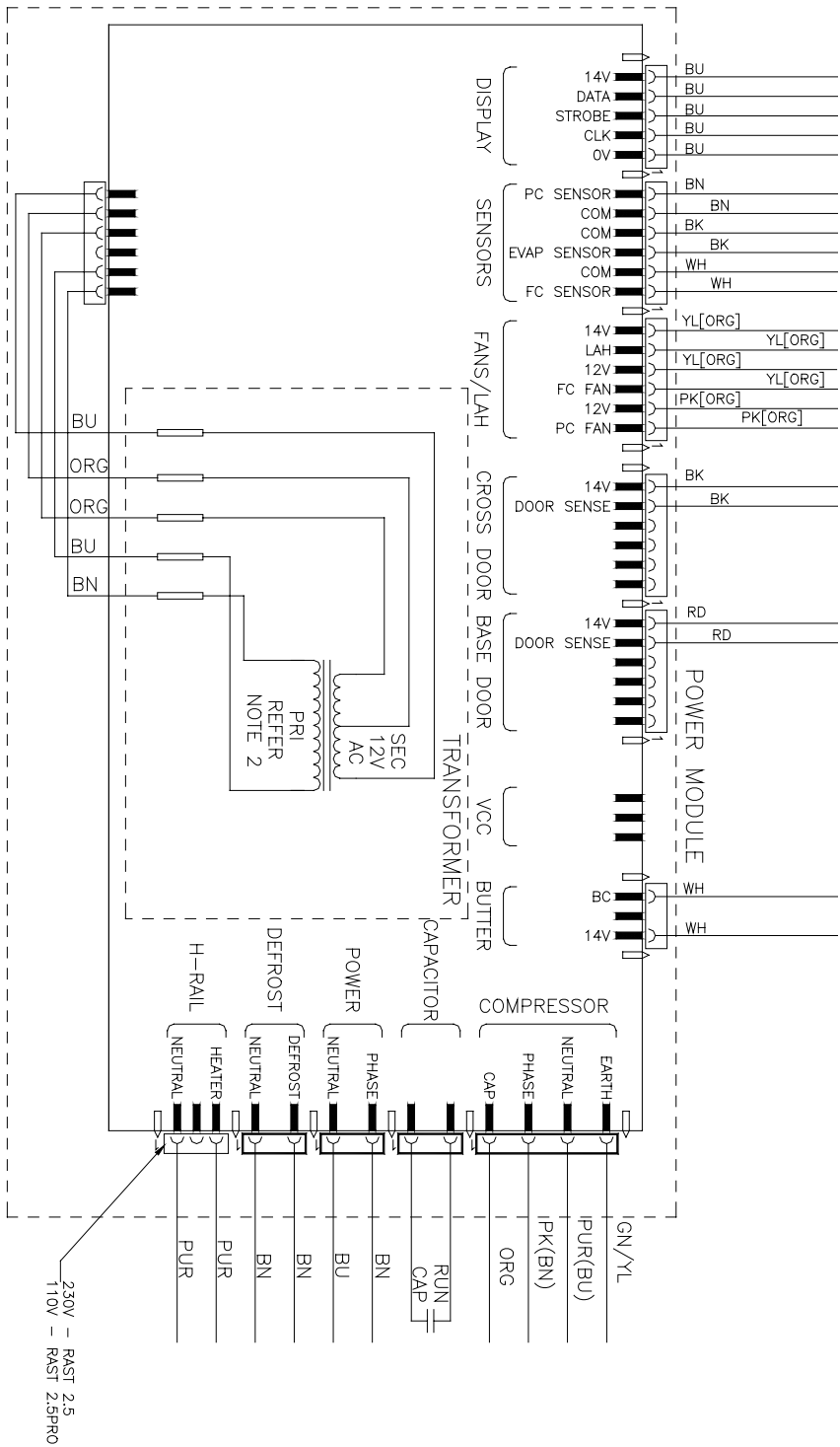

230V - RAST 2.5
 110V - RAST 2.5/PRO

www.fisherandpaykel.cn

Fisher & Paykel

Copyright © Fisher & Paykel 2009. All rights reserved.

The product specifications in this booklet apply to the specific products and models described at the date of issue. Under our policy of continuous product improvement, these specifications may change at any time. You should therefore check with your Dealer to ensure this booklet correctly describes the product currently available.